



www.serid.ait.ac.th/eric

Optimal Power Flow Considering Non-Linear Fuzzy Network and Generator Ramprate Constrained

Keerati Chayakulkheeree^{*1} and Weerakorn Ongsakul[†]

Abstract- This paper proposes a fuzzy constrained optimal power flow (FCOPF) algorithm with non-linear fuzzy network and generator ramprate limit constraints. The problem is decomposed into total fuel cost fuzzy minimization subproblem and total real power loss fuzzy minimization subproblem, which are solved by fuzzy linear programming (FLP). In the total fuel cost fuzzy minimization subproblem, the line flow and transformer loading limits and the generator ramprate limits are treated as fuzzy constraints. Whereas, in the total real power loss fuzzy minimization subproblem, the bus voltage magnitude limits are treated as fuzzy constraints. The non-linear S-shapemembership function is used for representing soft characteristic of fuzzy constraints. The proposed FCOPF algorithm is tested on the IEEE 30 bus test system with and without lines outage cases. The results show that the fuzzy constrained optimal power flow algorithm can successfully trade off among total fuel cost, line flow and transformer loading and generator ramprate in the total fuel cost fuzzy minimization subproblem and between total real power loss and bus voltage magnitude in the total real power loss fuzzy minimization subproblem.

Keywords - optimal power flow, fuzzy linear programming, ramprate limit.

1. INTRODUCTION

Optimal power flow program is used to determine the optimal operating state of a power system by optimizing particular objectives while satisfying certain specified physical and operating constraints [1]. Due to its capability of integrating the economic and security aspects of the concerned system into one mathematical formulation, OPF has been attracting by many researchers. The solution techniques for the OPF problem include linear programming, quadratic programming, gradient methods, interior point techniques [2-3], and stochastic optimization models [4-5]. In general, constraints in OPF are usually given fixed values that have to be met all the time, leading to over conservative solution. In addition, when the constraints are severely violated, crisp constrained OPF may not be able to obtain the feasible solution and it is difficult to decide which constraint should be relaxed and the extent of relaxation. Presently, increase in electricity consumption pushes the power systems to operate closer to their secure limits due to economical reasons. This has exacerbated the traditional conflict between the two major objectives of power system operation: economic and security. Therefore, certain trade-off among objective function and constraints is more desirable than rigid constraint solution [6].

Using fuzzy set theory, an OPF problem can be modified to include fuzzy constraints (for security) and fuzzy objective function (for economic operation). These developments overcome some of the limitations of the crisp constrained OPF. For example, Guan et al

[6] applied a fuzzy set method taking into account the fuzzy nature of the line flow constraints in OPF. Edwin Liu and Guan [7] applied a fuzzy set method to efficiently model the fuzzy line flow limits and control action curtailment in OPF. Nevertheless, the methods were aimed at treating line flow limit as linear fuzzy constraint in optimal real power dispatch excluding optimal reactive power dispatch. Meanwhile, the fuzzy voltage constraints have been applied to the real power loss minimization problem in [8] and [9]. However, the methods were aimed at treating only voltage magnitude limit as linear fuzzy constraints in optimal voltage controls without optimal real power dispatch. In addition, it is quite obvious that linear membership function is usually not adequate for fuzzy constraints representations. Non-linear membership functions can provide better representation of soft characteristic of practical constraints than linear membership functions [10]. In our previous work [11], the fuzzy constrained optimal power dispatch was formulated for electricity and ancillary services markets without generator ramprate constraints. Whereas, real power loss was minimized by LP with crisp bus voltage magnitude constraints.

This paper proposes a non-linear fuzzy constrained optimal power flow (FCOPF) algorithm including non-linear fuzzy line flow and transformer loading limits, generator ramprate and bus voltage magnitude constraints. The problem is decomposed into total fuel cost fuzzy minimization subproblem and total real power loss fuzzy minimization subproblem, which are solved by fuzzy linear programming (FLP). In the total fuel cost fuzzy minimization subproblem, the line flow and transformer loading limits constraints and the generator ramprate constraints are treated as fuzzy constraints. Whereas, in the total real power loss fuzzy minimization subproblem, the bus voltage magnitude limits are treated as fuzzy constraints. The proposed FCOPF algorithm is tested on the modified IEEE 30 bus system with and without line outages conditions. Comparisons on the proposed FCOPF algorithm and crisp constrained optimal power flow are shown and discussed.

^{*}Department of Electrical Engineering, Faculty of Engineering, Sripatum University, Jatujak, Bangkok 10900, Thailand.

[†]Energy Field of Study, Asian Institute of technology, P.O. Box 4, Klong Luang, Pathumthani 12120, Thailand.

¹Corresponding Author:
E-mail: keerati.ch@spu.ac.th

The organization of this paper is as follows. Section II addresses the FCOFP problem formulation. The FCOFP algorithm is given in Section III. Numerical results on the IEEE 30 bus test system are illustrated in Section IV. Lastly, the conclusion is given.

2. FCOFP PROBLEM FORMULATION

In the proposed model, the optimal operating point is carried out by FCOFP in 30 min interval. The FCOFP problem is formulated as two fuzzy minimization subproblems which are solved by fuzzy linear programming (FLP).

a) Total fuel cost fuzzy minimization subproblem

The objective function of total fuel cost fuzzy minimization subproblem can be expressed as,

$$\text{Minimize } FC = \sum_{i \in BG} F(P_{Gi}). \tag{1}$$

To solve the total fuel cost fuzzy minimization subproblem by FLP, the generator fuel cost functions are linearized into pieced-wise linear cost function and the linearized objective function is,

$$\text{Minimize } FC = \sum_{i \in BG} \sum_{j=1}^{NS_i} S_{ij} P_{Gij}, \tag{2}$$

Subject to the power balance constraints,

$$P_{Gi} - P_{Di} = \sum_{j=1}^{NB} |V_i| |V_j| |y_{ij}| \cos(\theta_{ij} - \delta_{ij}), i = 1, \dots, NB \tag{3}$$

$$Q_{Gi} - Q_{Di} = \sum_{j=1}^{NB} |V_i| |V_j| |y_{ij}| \sin(\theta_{ij} - \delta_{ij}), i = 1, \dots, NB \tag{4}$$

Where,

$$P_{Gi} = \sum_{j=1}^{NS_i} P_{Gij}, i \in BG, \tag{5}$$

$$0 \leq P_{Gij} \leq P_{Gij}^{max}, i \in BG, j = 1, \dots, NS_i \tag{6}$$

And the fuzzy line flow limit and transformer loading constraints,

$$|f_l| \leq f_l^{max}, for l = 1, \dots, NC, \tag{7}$$

And fuzzy generator ramprate constraints,

$$P_{Gi}^0 - R_{Gi}^{up} \cdot \tilde{Min} \leq P_{Gi} \leq P_{Gi}^0 - R_{Gi}^{down} \cdot \tilde{Min}, i = 1 \dots NR, \tag{8}$$

and the generator minimum and maximum operating limit constraints,

$$P_{Gi}^{min} \leq P_{Gi} \leq P_{Gi}^{max}, i \in BG. \tag{9}$$

S_{ij} and P_{Gij} are obtained by linearizing the generator i fuel cost function into NS_i segments linear cost function as shown in Fig. 1. The line flow limit constraints in Eq. (7) are computed by line flow sensitivity factor [12]. P_{Gij} , $i \in BG, j = 1, \dots, NS_i$, are the unknown control variables obtained from the total fuel cost fuzzy minimization subproblem.

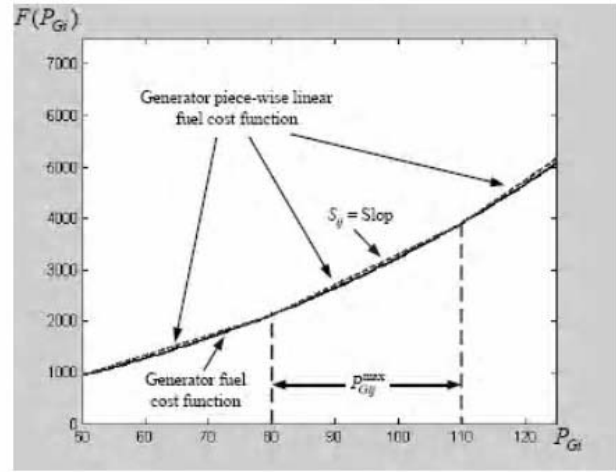

Fig. 1. Generator fuel cost and piece-wise linear fuel cost functions.

b) Real power loss fuzzy minimization subproblem

To minimize the total real power loss, the total real power loss minimization subproblem is solved iteratively with the total fuel cost fuzzy minimization subproblem. The objective is formulated as,

$$\text{Minimize } \Delta P_{loss} = \left[\frac{dP_{loss}}{d|V|} \quad \frac{dP_{loss}}{dT} \right] \begin{bmatrix} \Delta|V| \\ \Delta T \end{bmatrix}, \tag{10}$$

Subject to the fuzzy bus voltage limits constraints,

$$\Delta|V_i^{min}| \leq \Delta|V_i| \leq \Delta|V_i^{max}|, for i = 1, \dots, NV, \tag{11}$$

where,

$$\Delta|V_i^{min}| = |V_i^{min}| - |V_i|, for i = 1, \dots, NV, \tag{12}$$

$$\Delta|V_i^{max}| = |V_i^{max}| - |V_i|, for i = 1, \dots, NV, \tag{13}$$

and the transformer tap-change limits constraints,

$$\Delta|T_i^{min}| \leq \Delta|T_i| \leq \Delta|T_i^{max}|, for i = 1, \dots, NT, \tag{14}$$

where

$$\Delta|T_i^{min}| = |T_i^{min}| - |T_i|, for i = 1, \dots, NT, \tag{15}$$

$$\Delta|T_i^{max}| = |T_i^{max}| - |T_i|, for i = 1, \dots, NT, \tag{16}$$

$$Q_{Gi}^{min} \leq Q_{Gi} \leq Q_{Gi}^{max}, i \in BG. \tag{17}$$

$dP_{loss}/d|V|$ and dP_{loss}/dT are obtained by unified Jacobian matrix [13] and the detail formulation is given in [11]. $|V_i|$, $i \in BG$, and T_i , $i = 1, \dots, NT$, are the unknown control variables obtained from the total real power loss fuzzy minimization subproblem.

3. FCOFP ALGORITHM

a) FLP formulation for total fuel cost fuzzy minimization subproblem

To solve the total fuel cost fuzzy minimization subproblem, the goal of decision-maker can be expressed as a fuzzy set the solution space is defined by constraints that can be modeled by fuzzy set [10]. The total fuel cost

fuzzy minimization subproblem of the proposed FCOPF can be formulated as,

$$\text{Maximize min } \{ \mu_1(x), \mu_2(x), \dots, \mu_{1+NR+NC}(x) \}, \quad (18)$$

$$\text{Subject to } \mathbf{B} \times \mathbf{P}_{Gij} \lesssim \mathbf{d}, \quad (19)$$

$$\text{where } \mathbf{P}_{Gij} = \begin{bmatrix} P_{G1} \\ \vdots \\ P_{G_{NGNS_{i,j}}} \end{bmatrix}_{i \in BG} \sum_{j \in BG} NS_j \quad (20)$$

and power balance constraints in (2) and (3), low and high limits of \mathbf{P}_{Gij} in (6), and crissps inequality constraints in (9).

\mathbf{d} is the vector representing of fuzzy limit constraints in Eqs. (7) and (8). Each row of \mathbf{B} in (19) is represented by a fuzzy set with the membership functions of $\mu_i(x)$. $\mu_i(x)$ can be interpreted as the degree to which \mathbf{P}_{Gij} satisfies either the fuzzy objective function or inequality constraint i . Here, $\mu_1(x)$ is the degree of satisfaction of \mathbf{P}_{Gij} for the objective function, whereas $\mu_2(x)$ to $\mu_{1+NR}(x)$ are the degrees of satisfactions of \mathbf{P}_{Gij} for the generator ramprate constraint for increasing ang decreasing real power generations. If there are NC lines and transformers violating their loading limits, $\mu_{2+NR}(x)$ to $\mu_{1+NR+NC}(x)$ will represent the degrees of satisfactions of \mathbf{P}_{Gij} for the line flow constraints. In this paper, the hyperbolic function is used to represent the nonlinear, S-shaped, membership function [10, 11]. The function can be expressed as,

$$\mu_i(x) = \frac{1}{2} \cdot \tanh \left(\left(\mathbf{B}_i \cdot \mathbf{P}_{Gij} - \frac{\alpha_i + \beta_i}{2} \right) \cdot \gamma_i \right) + \frac{1}{2}, \quad (21)$$

where α_i , β_i , and γ_i are the parameters representing the shape of $\mu_i(x)$ depending on the decision maker. \mathbf{B}_i is the row i of \mathbf{B} . To obtain the membership function of objective function, α_1 is the minimum total fuel cost solved by the LP when all constraints are within the normal limits.

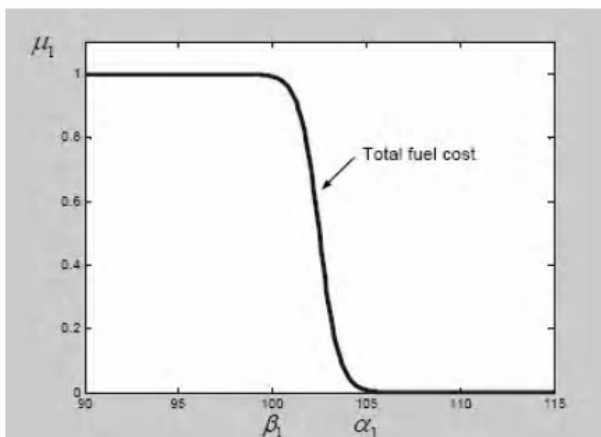

Fig. 2. Membership function for total operating fuel cost.

On the other hand, β_1 is the minimum total fuel cost solved by the LP when relaxing all constraints to their maximum acceptable violating limits. γ_1 is obtained by α_1 / β_1 as shown in Fig. 2. For the fuzzy line flow and transformer loading constraints, α_i is set to normal line flow limit or transformer loading constraint, β_i is set to 110% of normal line flow limit or transformer loading

constraint. γ_i is obtained by α_i / β_i as shown in Fig. 3. On the other hand, for the generator ramprate constraints, β_i is set to normal ramprate, α_i is set to 110% of normal ramprate constraints. γ_i is obtained by α_i / β_i as shown in Fig. 4.

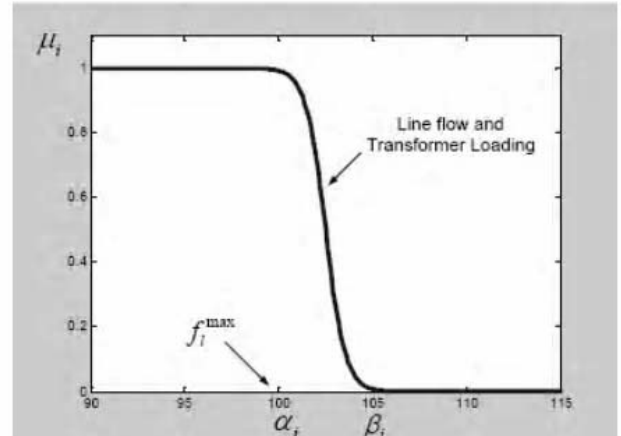

Fig. 3. Membership function for line flow and transformer loading.

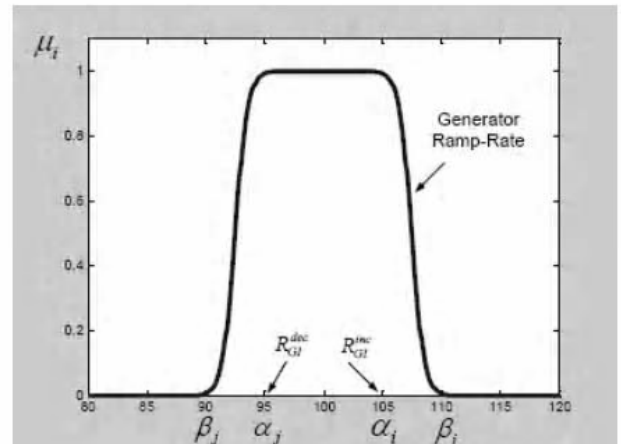

Fig. 4. Membership function for generator ramprate constraints.

With the defined membership functions of objective function and fuzzy constraints, the fuzzy optimization problem can be reformulated as,

$$\text{Maximize } \mu', \quad (22)$$

$$\text{subject to } \mu' \leq \mu_i(x), \text{ for } i=1, \dots, 1+NR+NC, \quad (23)$$

$$\text{and } 0 \leq \mu' \leq 1, \quad (24)$$

and power balance constraints in (2) and (3), low and high limits of \mathbf{P}_{Gij} in (6), and crissps inequality constraints in (9).

b) FLP formulation for total real power loss fuzzy minimization subproblem

The total real power loss fuzzy minimization subproblem of the proposed FCOPF can be formulated as,

$$\text{Maximize min } \{ \lambda_1(x), \lambda_2(x), \dots, \lambda_{1+NR}(x) \}, \quad (25)$$

$$\text{Subject to } \mathbf{G} \cdot \begin{bmatrix} \mathbf{V} \\ \mathbf{T} \end{bmatrix} \lesssim \mathbf{h}, \quad (26)$$

and power balance constraints in (2) and (3), crisp inequality constraints in (14) and (17), and low and high limits of \mathbf{V} and \mathbf{T} in (12), (13), (15), and (16).

\mathbf{h} is the vector representing of crisp limit constraints from Eq. (11). Each row of \mathbf{G} in (26) is interpreted as the degree to which vector $[\mathbf{V} \ \mathbf{T}]^T$ satisfies either the fuzzy objective function or inequality constraint i . $\lambda_i(x)$ represents the objective function in (10) and $\lambda_i(x)$, $i = 2, \dots, 1+NV$, represent fuzzy inequality constraints of the problem in (11). Similar to the total fuel cost fuzzy minimization subproblem, the S-shaped membership function for fuzzy bus voltage magnitude constraint is expressed as,

$$\lambda_i(x) = \frac{1}{2} \cdot \tanh\left(\left(\mathbf{G}_i \cdot \begin{bmatrix} \mathbf{V} \\ \mathbf{T} \end{bmatrix} - \frac{\rho_i + \omega_i}{2}\right) \cdot \sigma_i\right) + \frac{1}{2}, \quad (27)$$

where, \mathbf{G}_i is the row i of \mathbf{G} and ρ_i is the minimum total real power loss solved by the LP when all constraints are within the normal limits. On the other hand, ω_i is the minimum total real power loss solved by the LP when relaxing all constraints to their maximum acceptable violating limits. $1/\sigma$ is obtained by ρ_i / ω_i as shown in Fig. 5. For the fuzzy voltage limit constraints, ρ_i and ω_i , $i = 2, \dots, 1+NV$, are set to normal limit and ω_i , $i = 2, \dots, 1+NV$, are set to 5% violation on the limit. σ_i are obtained by ρ_i / ω_i for both low voltage and high voltage limits, as shown in Fig. 6.

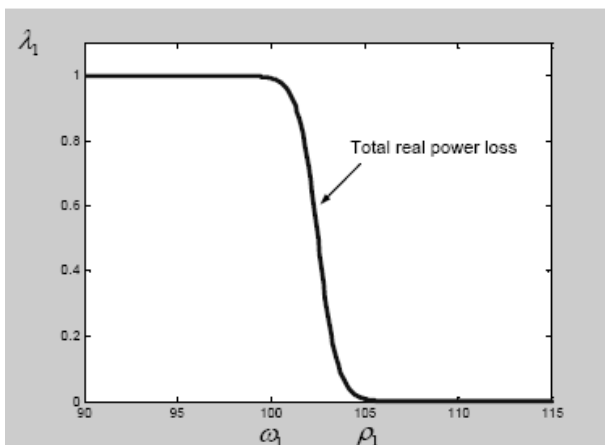

Fig. 5. Membership function for total real power loss.

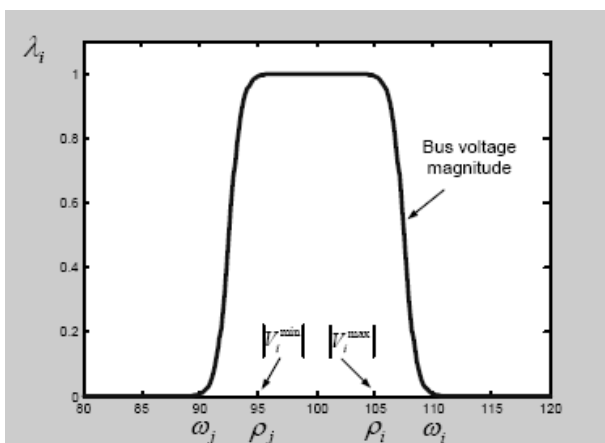

Fig.6. Membership function for bus voltage magnitudes.

c) Computational Procedure

The computational procedure of FCOPF is shown in Fig. 7. FLP₁ refers to the FLP algorithm of Section 3.a whereas FLP₂ is the FLP algorithm of Section 3.b.

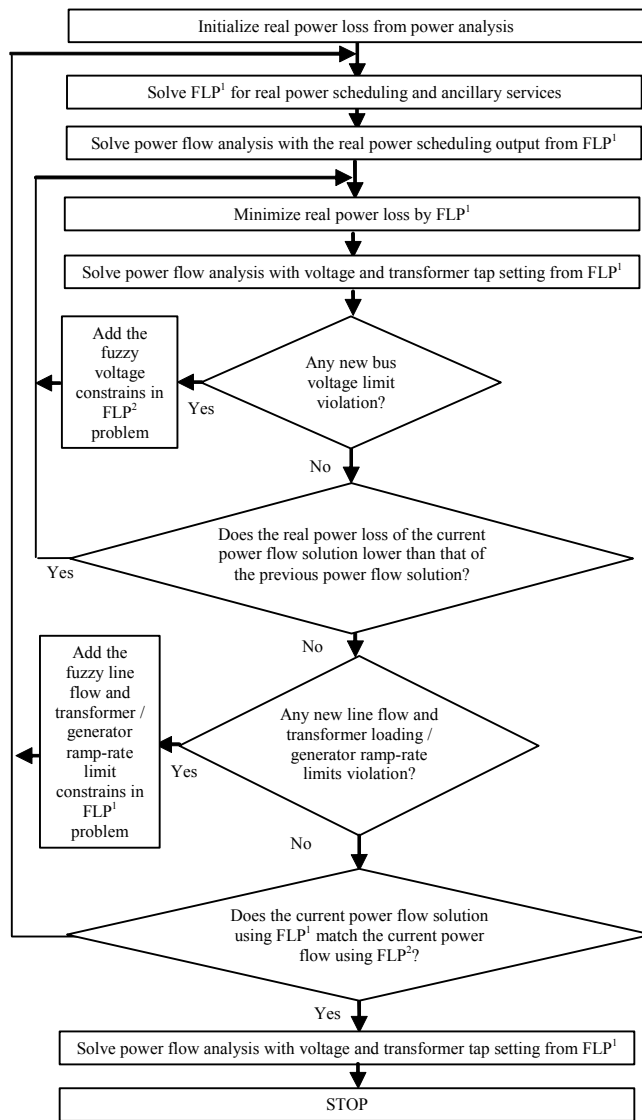

Fig. 7. Computational procedure.

4. SIMULATION RESULTS

a) IEEE 30 bus system

The IEEE 30 bus system [14] is used as the test data. Its network diagram is shown in Figure 8. The generator fuel cost functions are given in third order polynomial function as shown in Table 1.

Table 1. Generator fuel cost parameter and operating limits

Gen Bus	Min (MW)	Max (MW)	$F(P_{Gi}) = a_i \cdot P_{Gi}^3 + b_i \cdot P_{Gi}^2 + c_i \cdot P_{Gi} + d$				Ramp Rate (MW/30min)	
			a_i	b_i	c_i	d_i	Up	Down
1	50	200	0.0010	0.092	14.5	-136	15	20
2	20	80	0.0004	0.025	22	-3.5	10	15
5	15	50	0.0006	0.075	23	-81	6	10
8	10	35	0.0002	0.1	13.5	-14.5	4	8
11	10	30	0.0013	0.12	11.5	-9.75	4	8
13	12	40	0.0004	0.084	12.5	75.6	5	10

The fuel cost function are linearized into piecewise linear cost curve as shown in Figure 9. In the simulation, the generator and load bus operating ranges of voltage magnitudes are 0.95-1.1 p.u. The generators ramprate limits for both increasing and decreasing real power generation are shown in Table 1. The algorithm has been tested with several cases with different system conditions.

Feasible solutions can not be obtained by the crisp constrained OPF for some particular severe system conditions. The simulations include (i) base case: with normal operating condition and (ii) line outages case: with outages simulation of lines 2-5 and 2-4, as shown by dash lines in Fig. 8.

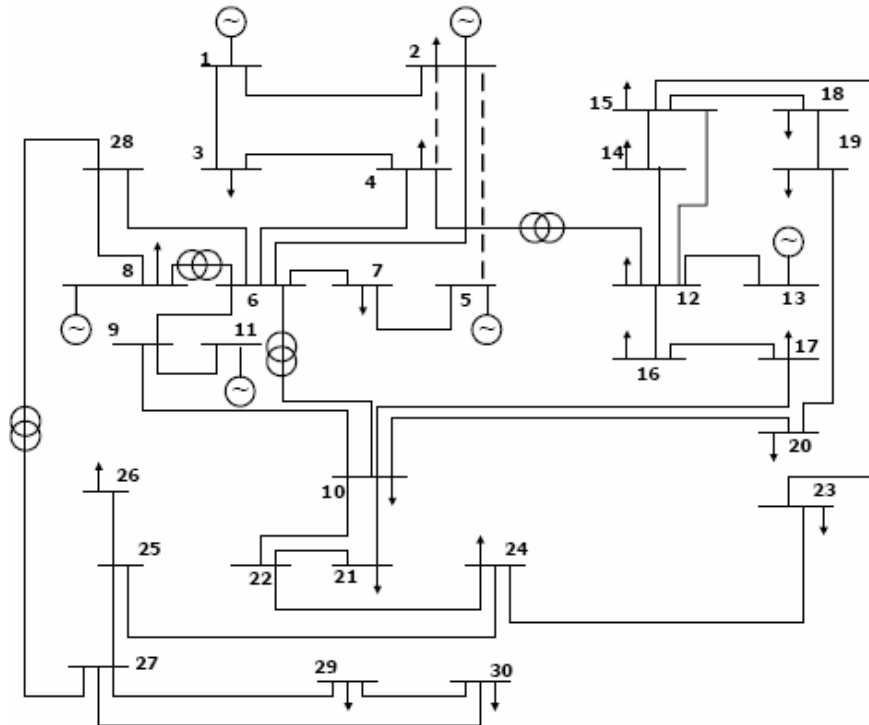

Fig.8. IEEE 30 bus test system network diagram.

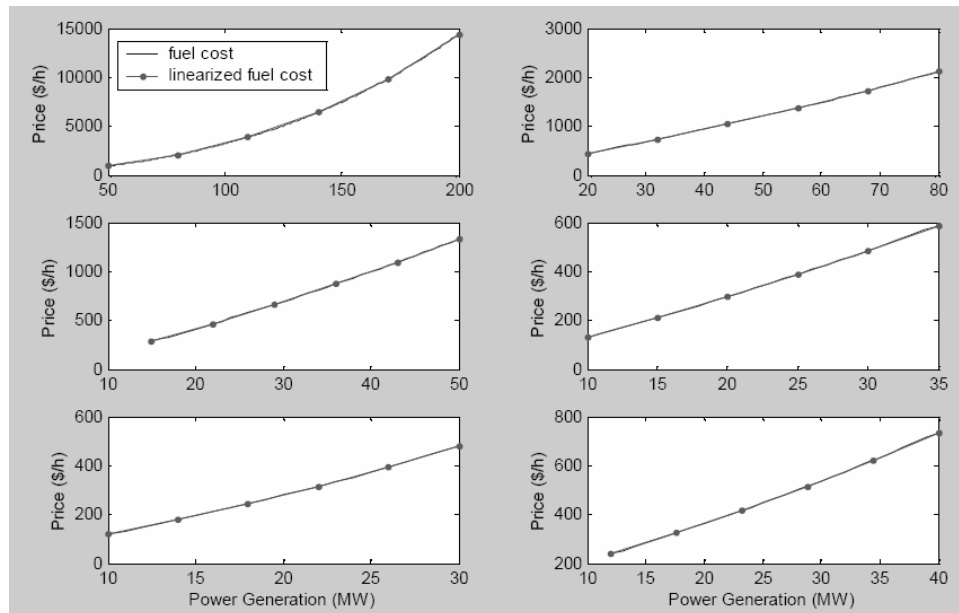

Fig.9. Generators fuel costs and linearized fuel costs of IEEE 30 bus test system.

Base case: normal operating condition

The original IEEE 30 bus system given in [14] is used to test the proposed FCOFP. Table 2 shows the simulation results including control variables, constraint violations, real and reactive power dispatch, total real power loss and total fuel cost of crisp constrained OPF and the proposed FCOFP for base case. In this case, all line and transformer operate within their loading limits.

The simulation shows that the total fuel cost of crisp constrained OPF is lower than initial condition whereas FCOFP is lower than that of initial condition and crisp constrained OPF by 1.8% and 0.6%, respectively. With the fuzzy treatment on bus voltage magnitude limits, the total real power loss of FCOFP is 18.25% and 2.5% lower than initial condition and crisp constrained OPF, respectively. Note the ramprate of generator connected to

bus 5 is 5% slightly higher than its normal operating limit.

Table 2. Simulation results of IEEE 30 bus system base case

Description			Initial	Crisp Constrained OPF	FCOPF
Control Variables	V (p.u.)	V ₁	1.060	1.100	1.105
		V ₂	1.045	1.097	1.104
		V ₅	1.010	1.064	1.069
		V ₈	1.010	1.066	1.071
		V ₁₁	1.082	1.100	1.105
		V ₁₃	1.071	1.100	1.105
	P _G (MW)	P _{G1}	72.6	66.9	59.3
		P _{G2}	70.0	69.0	76.5
		P _{G5}	40.0	46.0	46.3
		P _{G8}	35.0	35.0	35.0
		P _{G11}	30.0	30.0	30.0
		P _{G13}	40.0	40.0	40.0
	Tap	T ₄₋₁₂	0.932	0.9880	0.9930
T ₆₋₉		0.978	1.0340	1.0390	
T ₆₋₁₀		0.969	1.0250	1.0300	
T ₂₈₋₂₇		0.968	1.0175	1.0231	
Constraints Violation	V ₁	-	1.100	1.105	
	V ₂	-	-	1.104	
	V ₁₁	-	-	1.105	
	V ₁₃	-	1.100	1.105	
	R _{G5^{up}}	-	6.00	6.3	
Total Power Generation (MW, MVar)			287.62, 85.97	286.94, 79.67	286.85, 78.95
Total system loss (MW)			4.22	3.54	3.45
Total fuel cost (\$/h)			6380.89	6307.28	6268.03

Table 3. Simulation results of IEEE 30 bus system with lines 2-4 and 2-5 outage

Description			Initial	Crisp Constrained OPF	FCOPF
Control Variables	V (p.u.)	V ₁	1.060	1.100	1.105
		V ₂	1.045	1.100	1.105
		V ₅	1.010	1.032	1.038
		V ₈	1.010	1.082	1.088
		V ₁₁	1.082	1.100	1.105
		V ₁₃	1.071	1.100	1.105
	P _G (MW)	P _{G1}	77.8	77.1	60.0
		P _{G2}	70.0	62.5	79.6
		P _{G5}	40.0	46.0	45.83
		P _{G8}	35.0	35.0	35.0
		P _{G11}	30.0	30.0	30.0
		P _{G13}	40.0	40.0	40.0
	Tap	T ₄₋₁₂	0.932	1.004	1.0070
T ₆₋₉		0.978	1.050	1.0530	
T ₆₋₁₀		0.969	1.041	1.0440	
T ₂₈₋₂₇		0.968	1.023	1.0262	
Constraints Violation	f ₂₋₆	69.86	65.000	67.142	
	V ₁	-	1.100	1.105	
	V ₂	-	1.100	1.105	
	V ₁₁	-	1.100	1.105	
	V ₁₃	-	1.100	1.105	
Total Power Generation (MW, MVar)			292.75, 109.23	290.56, 100.19	290.43, 99.43
Total system loss (MW)			9.35	7.16	7.03
Total fuel cost (\$/h)			6616.50	6551.09	6396.30

Line outages case: with lines between buses 2 and 5 and between buses 2 and 4 outages

With lines 2-5 and 2-4 outages, the line 2-6 flow violates its limit of 65 MW. The control variables, constraint violations, real and reactive power dispatch, total real power loss and total fuel cost of crisp constrained OPF and the proposed FCOPF with lines outages are shown in Table 3.

Crisp constrained OPF results in binding constraints solution. The total fuel cost and total real power loss of crisp constrained OPF are lower than that of initial condition. Due to fuzzy line flow constraints, the total fuel cost of the FCOPF is 2.4% lower than crisp constrained OPF. Whereas, the total real power loss of FCOPF is 1.8% lower than that of crisp constrained OPF. Note the line 2-6 flow of 67.142 MVA is 3.29% slightly higher than its limit of 65 MVA.

b) IEEE 118 bus system

Because some generators in the IEEE 118 bus test system are treated as synchronous condensers (no real power generation) and synchronous motors (negative real power generation), the bus connected to those machines are treated as voltage control bus with no real power generation in the modified IEEE 118 bus used in this paper. The data of modified IEEE 118 bus test system is given in [15]. The results of IEEE 118 bus system are shown in Table 4.

Table 4. Simulation results of modified IEEE 118 bus test system

Description	Initial	Crisp Constrained OPF	FCOPF
Total Power Generation (MW, MVar)	3836.37, -295.99	3871.17, -31.11	3856.23, 260.56
Total system loss (MW)	168.37	203.17	188.23
Total fuel cost (\$/h)	319,741	299,746	299,703

The total fuel cost and total real power loss of crisp constrained OPF are lower than that of initial condition with binding solution of the lines flow limit between bus 65 and 68 of 540 MW. Due to fuzzy line flow constraints, the total fuel cost of the FCOPF is shown to be the lowest with the line 65-68 flow of 549.344 MVA, 0.797% slightly violating its limit.

5. CONCLUSION

In this paper, a fuzzy constrained optimal power flow (FCOPF) algorithm with non-linear fuzzy network and generator ramp rate constraints is efficiently and effectively minimizing the total fuel cost and total real power loss by FLP in power system. The results show that the fuzzy constrained optimal power flow algorithm can successfully trade off among total fuel cost, line flow and transformer loading and generator ramp rate in the total fuel cost fuzzy minimization subproblem and between total real power loss and bus voltage magnitude in the total real power loss fuzzy minimization subproblem, leading to the lower total fuel cost than that of crisp constrained optimal power flow.

REFERENCES

- [1] H. W. Dommel and W. F. Tinney. 1968. Optimal Power Flow Solutions. *IEEE Trans. Power Appar. Syst.* PAS-87:1866-1876.
- [2] J. A. Momoh, M. E. El-Hawary, and R. Adapa. 1999. A Review of Selected Optimal Power Flow Literature to 1993 Part I: Nonlinear and Quadratic Programming Approaches. *IEEE Trans. Power Syst.*, 14, (1):96-104.
- [3] J. A. Momoh, M. E. El-Hawary, and R. Adapa. 1999. A Review of Selected Optimal Power Flow Literature to 1993 Part II: Newton, Linear Programming and Interior Point Methods. *IEEE Trans. Power Syst.*, 14 (1): 105-111.
- [4] A. G. Bakirtzs, P. N. Biskas, Christoforos E. Zoumas, and V. Petridis. 2002. Optimal Power Flow by Enhanced Genetic Algorithm. *IEEE Trans. Power Syst.*, 17(2): 229-236.
- [5] J. Yuryevich and K. P. Wong. 1999. Evolutionary Programming Based Optimal Power Flow Algorithm. *IEEE Trans. Power Syst.*, 14, (4): 1245-1250.
- [6] Guan, W.-H. Edwin Liu and A. D. Papalexopoulos. 1995. Application of Fuzzy Set Method in an Optimal Power Flow. *Electric Power Systems Research.* 34 (1): 11-18.
- [7] W.-H. Edwin and Liu X. Guan. 1996. Fuzzy Constraint Enforcement and Control Action Curtailment in an Optimal Power Flow. *IEEE Trans. Power Syst.*, 11 (2) :639-645.
- [8] K. H. Abdul-Rahman and S. M. Shahidehpour. 1993. A Fuzzy-Based Optimal Reactive Power Control. *IEEE Trans. Power Syst.*, 8 (2):. 662-670.
- [9] K. Tomsovic. 1992. Fuzzy Linear Programming Approach to the Reactive Power/Voltage Control Problem. *IEEE Trans. Power Syst.*, 7 (1): 287-293.
- [10] H. J. Zimmermann. 1987. Fuzzy Sets, Decision Making, and Expert Systems, Boston, Kluwer Academic Publishers.
- [11] K. Chayakulkheeree and W. Ongsakul. 2005. Fuzzy Constrained Optimal Power Dispatch for Electricity and Ancillary Services Markets. *Electric Power Components and Systems*, 33 (4).
- [12] A. Wood and B. Wollenberg. 1996. Power Generation, Operation and Control, 2nd ed. New York: Wiley.
- [13] M. K. Mangoli, K. Y. Lee, and Y. M. Park. 1993. Optimal Real and Reactive Power Control Using Linear Programming. *Electric Power Systems Research*, 26: 1-10.
- [14] O. Alsac and B. Stott. 1973. Optimal Load Flow with Steady State Security. *IEEE Trans. Power Appar. Syst.*, PAS93 (3): 745-751.
- [15] K. Chayakulkheeree. 2005. Non-Linear Fuzzy Network Constrained Optimal Power Flow. Research report, Department of Electrical Engineering, Faculty of Engineering, Sripatum University, Thailand.

