



www.serd.ait.ac.th/eric

Comparison of Conventional and Open Flat Plate Collectors for Evaporation of Tannery Effluent (December 2006)

K. Srithar* and A. Mani

Abstract - An experimental study has been made to augment evaporation of tannery effluent (soak liquor) and compare the performance of the conventional fibre reinforced plastic (FRP) flat plate collector with an open FRP flat plate collector. As the tannery effluent flows over FRP flat plate collectors in the form of thin film, the effluent is heated by gaining heat from the absorber due to exposure to solar radiation. Hence, the partial pressure at the interface of the effluent increases, resulting to increase in pressure difference between the interface and air. Thus, leading to increase in mass transfer rate. In this paper, performance comparison is made between the FRP open flat plate collector and the conventional FRP flat plate collector, to understand the effect of climatic conditions, concentration and mass flow rate of the effluent. This study shows that the conventional FRP flat plate collector gives better performance than the open FRP flat plate collector.

Keywords - Solar flat plate collector, Fibre-reinforced plastic flat plate collector, Open flat plate collector, Conventional flat plate collector, Tannery effluent, Soak liquor, Effluent treatment.

1. INTRODUCTION

In this fast changing world, technology has seen a big revolution in almost all the fields. Though the development is drastic, they are accompanied by some tedious problems every now and then. One of the major challenges that threaten the living beings at present is pollution. Pollution control has now gained more importance with the advent of rapid modernization. Pollution of natural resource in any form such as air, water, land etc., is strictly viewed as an offence by the government and the implementation agencies like pollution control boards. Hence, the industries are instructed to strictly adhere to the various norms put forth by these bodies to reduce the pollution to the environment. The industries must come forward and put forth some efforts in maintaining a pollution free environment. With such a focus, solar flat plate collectors with and without glass (conventional flat plate collector) for evaporating water in tannery effluent (soak liquor) is studied, which provide a better solution for the problem of evaporation of this waste water stream, at an affordable cost economically.

Among the various industries, leather tanning industries face a serious problem of discharging the effluents (soak liquor) effectively without doing any harm to the environment. It has been an ordinary scene over the years that most of the tanneries drain their waste effluents into the near-by rivers or lakes. In certain cases they were also dumping the effluents into the land thus polluting it.

But natural streams at various places have already reached a point of saturation where they cannot receive any more effluents. Nevertheless partly due to non-availability of necessary information regarding total pollution load, assimilation capacity, harmful effects of pollutants on health of the river, etc. the industries still continue to discharge the soak liquor. This is very apparent in the case of tanneries because they contribute significantly to the organic load.

India is one of the largest producers of leather in the world with at present, more than 2500 tanneries with an annual processing capacity of 0.7 million tons of hides and skins. Although the tanning industry has been in existence for a long time, the problem of environmental pollution received serious consideration recently. The increasing requirement for a cleaner environment demands immediate measures for the control of pollution from tanneries. A number of studies in the characterization of tannery wastewater have been conducted and suggestions for their treatment were given [1-3, 8].

The water used for soaking, washing and liming is contaminated with huge amount of sodium chloride and acids. The effluents of this process called as soak liquor are characterized by very high solid concentration and a low pH value. The total dissolved solid (TDS) forms the major constituent of an effluent (soak liquor), which comprises of suspended solids, inorganic salts mainly constituting sodium chloride salt, soluble organic matter and the bacteria. The above said particles contribute to the chemical oxygen demand (COD) and the biological oxygen demand (BOD) etc. The sample of soak liquor tested [2] contains, with biochemical oxygen demand (BOD) levels of 900-6,000 mg/l, chemical oxygen demand (COD) levels of 850-1,200 mg/l, TDS ranging from 30,000-60,000 mg/l, suspended solids ranging from 4500-7000 mg/l, chloride ranging from 15,000-24,000 mg/l; and pH ranging from 7-8.

Chloride is introduced into tannery effluents as sodium chloride usually on account of the large quantities of

* Dr. K. Srithar is with the Department of Mechanical Engineering, Thiagarajar College of Engineering, Madurai - 625 015, India. Phone: (O): +91(0) 452 2482240 ; (R): +91 (0) 98421 85302 (M); Fax: +91(0) 452 2483427; E-Mail: ponsathya@hotmail.com

Dr. A. Mani is with the Department of Mechanical Engineering, Indian Institute of Technology - Madras, Chnnai - 600 036, India.

common salt used in hide and skin preservation or the pickling process. Being highly soluble and stable, they are unaffected by effluent treatment and nature, thus remaining as a burden on the environment. Considerable quantities of salt are used by these industries and levels can rapidly rise to the maximum level acceptable for drinking water. Increased salt content in groundwater, especially in areas of high industrial density, is now becoming a serious environmental hazard. Chlorides inhibit the growth of plants, bacteria and fish in surface waters; high levels can lead to breakdowns in cell structure. If the water is used for irrigation purposes, surface salinity increases through evaporation and crop yields fall. When flushed from the soil by rain, chlorides re-enter the eco-system and may ultimately end up in the ground water.

The suspended solids of an effluent (soak liquor) are the quantity of insoluble matter contained in the wastewater. These insoluble materials cause a variety of problems when discharged from a site; essentially, they are made up of solids with two different characteristics; Solids with rapid settling rate (settleable solids) comprise material that can be seen in suspension when an effluent sample is shaken, but settles when the sample is left undisturbed. The majority of these solids settle within 5 to 10 minutes, although some fine solids require more than an hour to settle. All this sludge has to be removed, transported, dewatered, dried and deposited, thus placing an inordinate strain on plant, equipment and resources. If the waste water is to be discharged into surface water, the rate of flow will determine the distance through which the material is carried before settling on the stream or river bed. Even a thin layer of settled sludge can form a blanket that deprives sections of the river or lakebed with paucity of oxygen.

Although stricter limits are often set, greater tolerance is shown towards higher pH since carbon-di-oxide from the atmosphere or from biological processes in healthy surface water systems tends to lower pH levels very effectively to neutral conditions. If the surface water pH shifts too far either way from the pH range of 6.5-7.5, sensitive fish and plant life are susceptible to loss. Municipal and common treatment plants prefer discharges to be more alkaline as it reduces the corrosive effect on concrete. Metals tend to remain insoluble and more inert, and hydrogen sulphide evolution is minimized. When biological processes are included as part of the treatment, the pH is lowered to more neutral conditions by carbon-di-oxide so evolved.

Many components in effluents are broken down by bacterial action into more simple components. Oxygen is required for both the survival of these bacteria (aerobic bacteria) and the breakdown of the components. Depending on their composition, this breakdown can be quite rapid or may take a very long time. If effluent with a high oxygen demand is discharged directly into surface water, the sensitive balance maintained in the water becomes overloaded. Oxygen is stripped from the water causing oxygen dependent plants, bacteria, fish as well as the river or stream itself to die. The outcome is an environment populated by non-oxygen dependent (anaerobic) bacteria

leading to toxic water conditions. A healthy river can tolerate substances with low levels of oxygen demand. The load created by tanneries, however, is often excessive, and the effluent requires treatment prior to discharge. This is often achieved by using bacteria in a properly operated effluent treatment plant: a process demanding high levels of oxygen. Oxygen induction can be achieved by blowing large volumes of air into the effluent.

Presently, taking advantage of the sunshine available for most part of the year, tanneries in Tamil Nadu, India, this soak liquor can be evaporated by discharging into ponds and the solid particles thus retained can be reused for further tanning process. The average rate of evaporation in Vellore district, Tamil Nadu, is 4.5 mm per day from the surface of natural lakes and ponds of non-saline water. Based on this average rate of evaporation, the pollution control authority has prescribed 222 m² area of solar pan for evaporation of 1 m³ of soak liquor per day. The volume of soak liquor generated while processing one tonne of raw material in a tannery ranges between 6500 and 10,000 litres. And therefore the area of solar pan required for evaporating this volume of soak liquor is between 1445 m² and 2220 m². All operating tanneries in Tamil Nadu, numbering about 700, have constructed and maintained solar pans for this purpose. Scarcity of land and its high cost have become serious constraints to expansion of tanning industry. Besides, continuing increase in the salinity of soil and groundwater in the Vellore district, which has the largest concentration of tanneries in India, has raised questions about the adequacy and the efficacy of the solar pans. The need for augmenting the effectiveness of the solar pans by accelerating evaporation has been articulated by the tanners and the pollution control authority of Tamil Nadu. Hence, some suitable techniques must be adopted to increase the evaporation rate.

The rate of evaporation from the shallow ponds can be increased by resorting any of the following methods listed below or combination of them.

1. Increasing the temperature of the effluent
2. Increasing the contact area between the effluent and air.
3. Heating the ambient air.
4. Reducing the humidity of air.
5. Increasing the velocity of air.

Of the above five, the last three possibilities are expensive and also difficult to realize in a simple manner. Instead, the first two can be combined and executed with minimal expenditure by which the evaporation rates can be increased. This can be achieved by allowing the effluents from the shallow basin to flow over an inclined solar flat plate collector. In this paper, an attempt is made to accelerate the rate of evaporation. This can be achieved by allowing the tannery effluent flow over on an inclined fibre reinforced plastic (FRP) flat plate collectors. A flat plate collector is an important device that utilizes both direct and diffuse radiation. It is simple in construction and easy to maintain. It finds widespread application in domestic water heating, industrial air heating, crop drying, desalination etc., because of the low output temperatures required in these applications.

In this work, efforts are being made to use the flat plate collector for effluent evaporation. The application of using flat plate collectors for tannery effluent evaporation was also studied by setting two model flat plate collectors: with and without glass. The effects of operational and meteorological parameters on evaporation rate are studied.

As the effluent trickles down as a thin film, the temperature of the solution increases, which in turn increase the partial vapour pressure of the water vapour in the effluent. This results in an increase in mass transfer between the effluent interface and the ambient. The open flat plate collector has the disadvantage of contaminations of the effluent. When the surface is covered with a transparent cover, this disadvantage is eliminated. Also, the evaporation rate may be increased comparatively due to reduction in top radiative heat loss.

In this work, experimental studies have been carried out at Madurai, India (latitude = 10° N) using two black FRP flat plate collectors (FPC) with and without glass cover. The two systems are made to operate simultaneously during experimentation over a period of one year. The impact of operational and meteorological parameters on evaporation rate is studied. Upon comparison, the evaporation rate of water in the effluent is found to increase for the increase in insolation, wind speed and decrease in relative humidity, mass flow rate and concentration. Also, the conventional flat plate collector evaporates more water than the open type.

2. DESCRIPTION OF THE SET UP

The schematic arrangement of the experimental system with glass (conventional system) is shown in Fig. 1. In the another system the glass cover is removed (not shown). The absorber surface is made up of FRP sheet with a size of 4 m in length, 1 m in width and 5 mm in thick. While preparing the sheets, black pigments are added to the resin and binder, to ensure maximum absorptivity, resulting to maximum absorption of radiation. The bottom of the sheet is covered with 75 mm thick glass wool to reduce the bottom loss. Copper constantan thermocouple wires (24 gauge) are used for the measurement of plate and solution temperatures. Thermocouple wires are inserted along the flow length of the collector to measure the plate temperature. Sixteen thermocouples were used to measure the plate temperature and six thermocouples were used to measure the solution temperatures. A temperature indicator integrated with selector switch is used to measure the temperature.

The supporting structures are fabricated by using 1.5 inch galvanized iron (GI) angles. The four corners are supported by GI pipes with 2 inch diameter. The loads are uniformly distributed in all joints of the supporting structures.

For both the systems, there are two tanks; tank A, a calibrated tank and tank B, a constant head tank, connected with pipe line L_1 , through the pump P and other pipe line L_2 . Both the tanks are plastic tanks with a capacity of 150 litres each. For experimentation, 250 litres of effluents are taken. Both the tanks are carefully closed while there is no

experimental work in order to avoid the contamination by dust.

In tank A, a calibrated piezometer is fitted to the side of the tank to measure the fall in water level. Since constant head is maintained in tank B, the evaporation rate is determined by means of the fall in piezometer level in the tank A. Fresh water is added at hourly intervals, to compensate the loss of water evaporated. Thus a constant concentration is maintained during experimentation. The effluent is transferred from tank A to tank B, by the pump P through the pipe line L_1 . The excess effluent from tank B is allowed to return back to tank A through the pipe line L_2 . Thus, constant head is maintained in the tank B.

One inch PVC pipes are used for pipe lines. Once constant head is maintained in the tank B, the valve V is opened and adjusted for the required flow rate. Thin film of effluent is made to flow over the collector by the distribution header D. One inch PVC pipe of length 1.2 m, and diameter 2 mm with 12 equispaced holes is used as the distribution header. This uniform equispaced holes help to uniform distribution of solution. Thus, uniform heating of the solution while it flows over the collectors is ensured. The liquor is collected at the collecting tray C, which is made of plastic sheet and then flows into tank A for recirculation.

In the case of the FRP-FPC with glass, a single cover is fixed by means of the wooden longitudinal side wall support. The wooden support helps not only to support the glass but also avoid the air flow through sides. The spacing between the plate and the glass cover is chosen as 100 mm by trial and error, to prevent condensation of water at the bottom of the glass cover. The bottom and top side walls of the conventional FPC are removed to permit the water vapour to escape upon vaporization.

- A – Calibrated Collection Tank
- B – Constant Head Tank
- C – Collecting Tray
- D – Distribution Header
- G – Glass
- K – Piezometer
- L_1 – Pipeline to Tank B
- L_2 – Return Pipeline to Tank A
- P – Centrifugal Pump
- V – Valve
- W – Wooden Frame
- X – Thermocouples

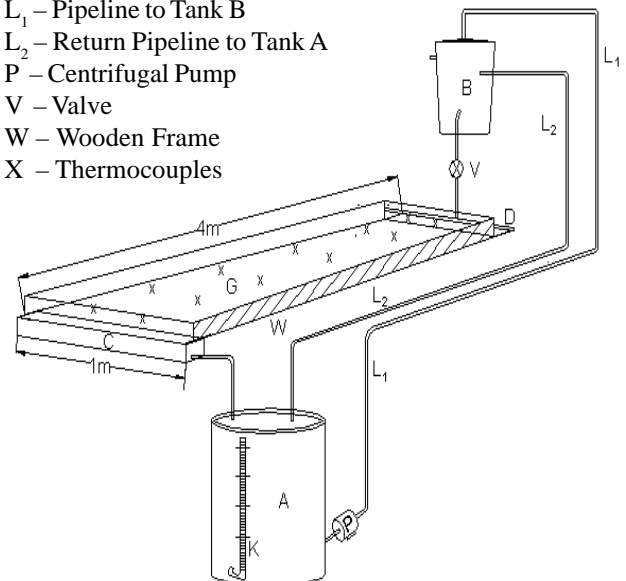

Fig. 1. Conventional FRP-FPC effluent evaporation system.

Upon evaporation of water content in the concentrated liquor the dried salt colour was brownish. The colour of the salt is attributed to suspended solids in it. So, to avoid the brownish colour, the plant is to be equipped with a sand filter. To decide about the above, laboratory experimentation was carried out by adding lime, alum, ferric chloride and ferrous sulphate. From these experiments, it is observed that addition of alum gives a fairly clear salt. The addition of lime also gives more or less the same result. Hence, keeping economy as the criteria, it is decided to use 100 ppm alum or lime and 250 ppm poly-aluminium chloride as additive for second stage presettling using the FRP hopper-bottom presettling system (not shown). The effluent is held for about two hours to allow complete settling, then the supernatant is discharged into the storage tank **A**.

3. EXPERIMENTATION

The pump **P** is started and the salt solution is transferred from the tank **A** to tank **B** through the pipe line L_1 . Once it reaches the required head, the excess soak liquor from the tank **B** is by-passed through the pipe line L_2 . Thereby, constant head is maintained in the tank **B**. The valve **V** is opened and adjusted for the required mass flow rate. This salt solution is made to flow with uniform thickness, over the collector by means of the distribution header. As the solution flows over the collector the temperature increases, which further increases the partial pressure difference between the interface of the solution and ambient. Hence, mass transfer from the solution to ambient increases. The heated soak liquor is collected in the channel **C** and from there it is transferred to the tank **A**. This completes one cycle.

During experimentation, the concentration of the effluent is maintained constant by adding a known quantity of fresh water to the tank **A** on an hourly basis. This known quantity of water is equal to the amount of water evaporated during this one hour, which is measured by using calibrated piezometer.

The solution flow rate flowing over the flat plate collector is measured by removing the distribution header and the time taken for collecting a known quantity of water in a measuring jar. A stopwatch of least count 0.01 second was used to measure the time taken for a known volume flow. Since constant head is maintained in the tank **B**, once the flow rate is adjusted by means of the valve **V**, it would not be changed throughout the experimental period.

The solar radiation is measured by using calibrated Kipp-Zonon solarimeter with integrator. The ambient temperature is measured by the calibrated mercury-in-glass thermometer. The solution temperatures and plate temperatures are measured by using calibrated copper-constantan thermocouples (24 gauge) with millivolt meter. Thermocouple beads are made in the inert formier gas atmosphere using a precision bead making machine. The thermocouples are inserted into the plate in 16 equal distances along the flow length of the collector in order to measure the plate temperature. Six thermocouples are used to measure the solution inlet and outlet temperatures. The

output emf of the thermocouple is measured using a high sensitivity digital micro-voltmeters. A rotary selector switch of negligible contact resistance is used to connect the thermocouples with the digital millivoltmeter. One end of the thermocouple is exposed to measure solution or plate temperature through selector switch, which act as a hot junction. The other end is inserted into common ice bath, which will be the cold junction.

Relative humidity of the air is inferred by the Hygrometer. It is then counter checked with dry bulb and wet bulb temperatures, using calibrated mercury-in-glass thermometers. The calibration is accomplished by exposing the sensor, to standard samples wherein a closed air space is maintained in equilibrium with a saturated aqueous salt solution.

Calibrated vane type anemometer is used for the measurement of wind speed. Concentration of the solution is estimated from the measurement of specific gravity, by using specific gravity meter. The various measuring sensors/instruments used and its accuracy is shown in the Table.1, along with the measured parameters range.

Table 1. Accuracies and ranges of measuring instruments

Sl. No.	Instrument	Accuracy	Range	Error %
1	Kipp-Zonon solarimeter	$\pm 0.05 \text{ W / m}^2$	0 – 5000 W/m^2	± 2.5
2	Digital Anemometer	$\pm 0.1 \text{ m / s}$	0 to 100 m/s	± 5
3	Wet and dry bulb thermometer	$\pm 0.5 \text{ }^\circ\text{C}$	-10°C to 50°C	± 4
4	Mercury-in-glass thermometer	$\pm 0.5 \text{ }^\circ\text{C}$	0°C to 120°C	± 4

During experimentation days, the experiment was started at 9 hour. Hourly measurements of parameters namely mass flow rate, effluent temperature, insolation, wet and dry bulb temperatures, wind speed and evaporation rate were carried out from 9 to 17 hours daily. These experiments were carried out for a period of one year by varying the mass flow rate of the effluent flowing over FRP flat plate collector and concentration. Experimentation is conducted for four different concentrations ranging from 5 to 20 % with increment of 5%. Similarly the mass flow rate is varied from 200 to 500 l/h with increment of 100 l/h.

4. RESULTS AND DISCUSSION

The operational parameters namely effluent concentration, mass flow rate and meteorological parameters namely wind speed, relative humidity and solar insolation are the factors affecting the evaporation rate of water in the effluent. During experimentation, the various parameters maintained and realized are given in the respective graphs.

As the concentration increases, the evaporation rate decreases. This is because, increase in concentration decreases the partial pressure of water in the effluent, which decreases the humidity differential between the interface of the effluent and the air. This effect can be seen in Fig. 2.

The deviation of the evaporation rate in the conventional type flat plate collector is about 5 to 23 % higher than the open flat plate collector. This may be attributed to reduction in radiative heat loss to the ambient.

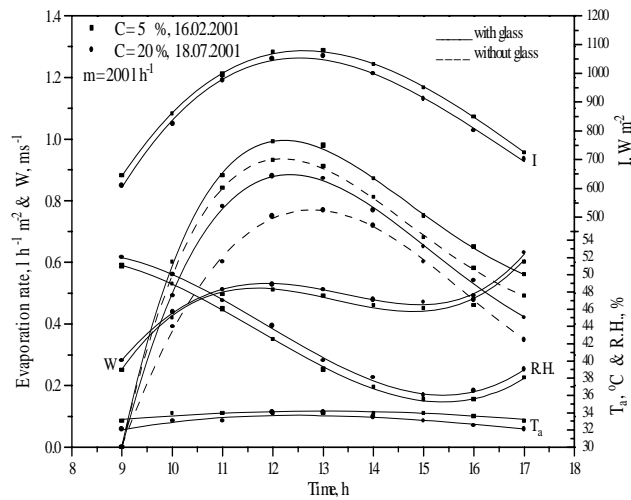

Fig. 2. Effect of concentration on evaporation rate.

Figure 3 exhibits the effect of mass flow rate on water evaporation rate. As the mass flow rate increases, the plate temperature decreases due to increase in heat transfer coefficient between the plate and the effluent. On the other hand, amount of heat required to raise the temperature of effluent increases due to increase in mass flow rate. Due to the overriding effect of the latter phenomena, the effluent temperature decreases. Resulting to decrease in partial pressure difference between the effluent and the air. Hence, the evaporation rate decreases with increase in mass flow rate.

The same trend can be seen for the open type collector with 4 to 12 percentage lower evaporation rate than that of open flat plate collector due to higher radiative heat loss to the ambient.

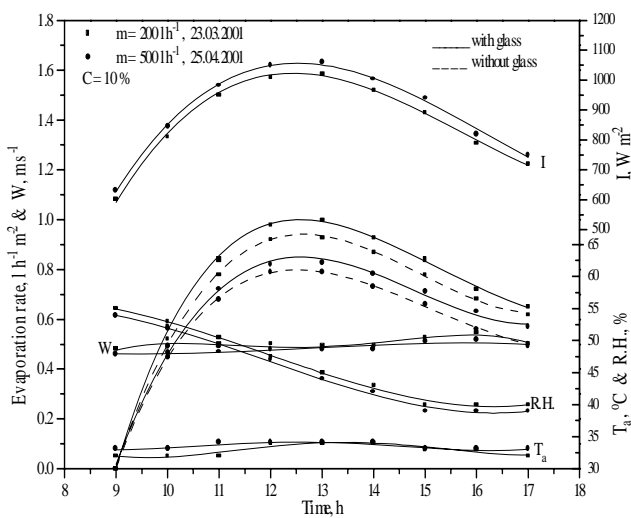

Fig. 3. Effect of mass flow rate on evaporation rate.

Increase in solar radiation causes increase in temperature of the absorber surface, which in turn increase the effluent temperature. Thus, resulting to increase in

evaporation rate. Figure 4 shows this effect. It can be observed from this figure, that evaporation rate in the flat plate collector is about 14 to 28 % higher than that of open flat plate collector due to reduction in radiation losses.

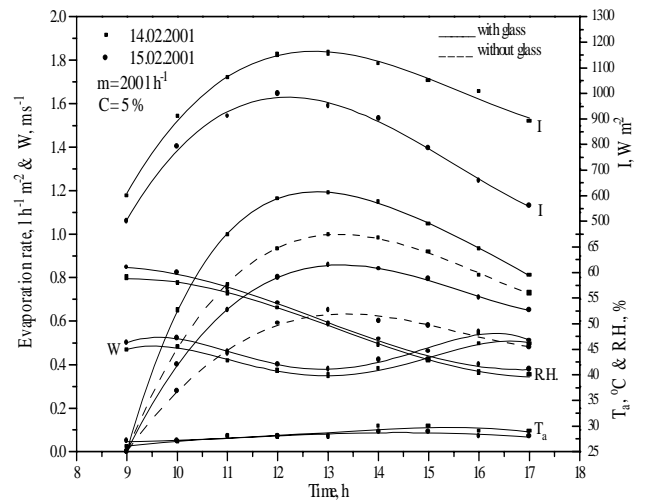

Fig. 4. Effect of solar insolation on evaporation rate.

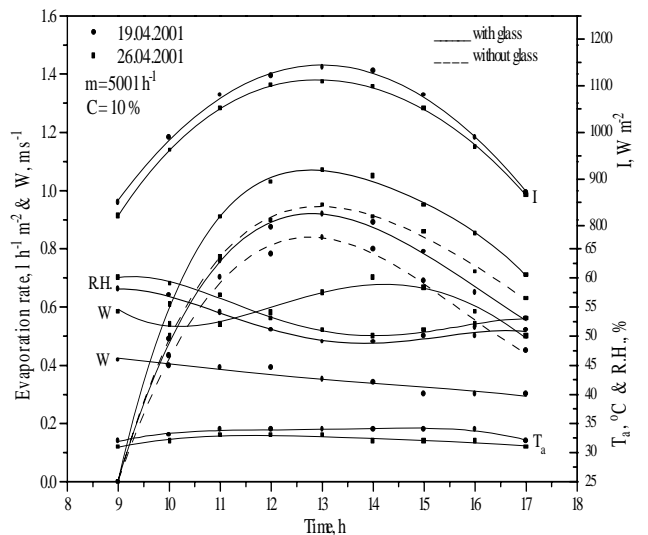

Fig. 5. Effect of wind speed on evaporation rate.

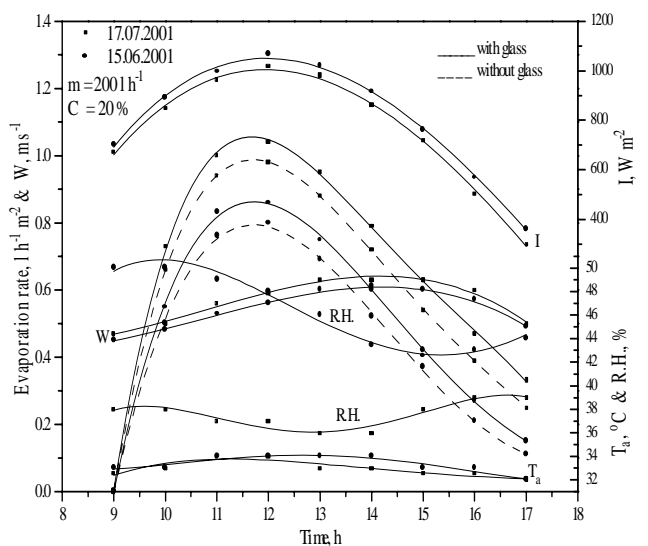

Fig. 6. Effect of humidity on evaporation rate.

As wind speed increases, amount of air comes in contact with effluent per unit time increases. This increases the mass transfer rate and thus evaporation rate. Figure 5 depicts this phenomenon. The flat plate collector gives about 8 to 23 % higher evaporation rate than that of the open flat plate collector for the same reasons mentioned above.

Higher the relative humidity, lower the partial pressure differences between the interface of the effluent and the air. So the evaporation rate reduces. This can be seen in Fig. 6. From this figure, it can be observed that evaporation rate is 4 to 19 % higher than that of the open type collector for the same reasons mentioned above.

Data obtained during the experimentation on both the open as well as conventional type FRP flat plate collectors are used for multi-non-linear regression analysis, in the ranges specified in Table 2. Error obtained for various measured parameters by error analysis is also presented in this table.

Table 2. Ranges of the operational and meteorological parameters

Sl. No.	Parameter	Unit	Range	Error %
1	Insolation	W / m ²	200 – 1200	± 2.5
2	Wind speed	m / s	0.2 - 1.7	± 5
3	Ambient temperature	⁰ C	25 – 36	± 4
4	Relative humidity	%	25 – 60	± 4
5	Solution concentration	%	5 – 20	± 0.4
6	Mass flow rate	l / h	200 - 500	± 0.27

Based on this analysis an empirical equation for evaporation rate is obtained as given in Eq.(1) and Eq.(2) as a function of the operational and meteorological parameters.

$$E = (0.006870T_a) - (0.017833W) + (0.00067I) - (0.003867RH) - (0.000284m) + (0.003582C) + 0.130946 \tag{1}$$

$$E = (0.004504T_a) - (0.071713W) + (0.000903I) - (0.001674RH) - (0.000075m) + (0.00099C) + 0.204967 \tag{2}$$

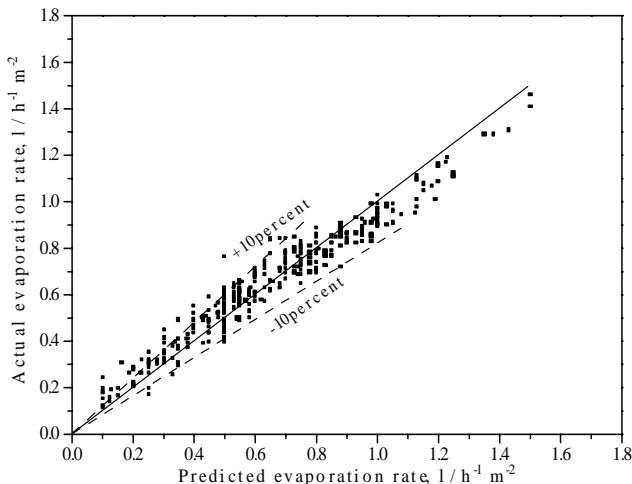

Fig. 7. Variation of actual evaporation rate with predicted evaporation values for open FRP solar flat plate collector.

Figure 7 shows the variation of the actual evaporation rate with predicted evaporation rate for open FRP flat plate collector. From this figure, it can be observed that the results agree well within ± 10 percent limits. Hence, this empirical correlation can be used as a design equation for establishing this kind of system.

Figure 8 presents the variation of actual evaporation rate with predicted evaporation rate for the conventional FRP solar flat plate collector.

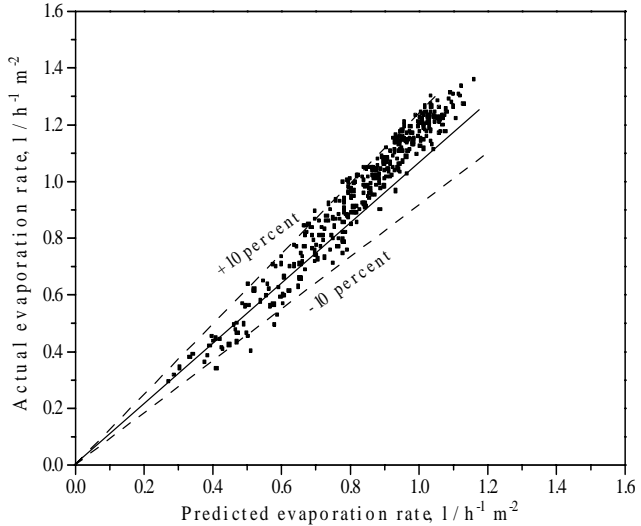

Fig. 8. Variation of actual evaporation rate with predicted evaporation values for conventional FRP solar flat plate collector.

It can be seen from the figure that the empirical correlation gives predicted values within ± 10 percent limit comparing to actually measured values. Equation 2 can be used for design of such a type of system.

5. CONCLUSIONS

The FRP-FPC is used successfully for evaporating tannery effluent withstanding corrosion problem. Experimentation was carried out on the Conventional Fibre Reinforced Plastic Flat Plate Collector (FRP-FPC) and open FRP-FPC simultaneously tested. The conventional FRP-FPC gives 4 to 28 % higher performance than the open FRP-FPC.

Based on the studies, empirical equations for the evaporation rate in open and conventional flat plate collectors are obtained, as a function of the operational and meteorological parameters. These equations can be used for design purposes in the given range of operating conditions for these kind of systems.

The improved systems are 3-4 times more effective than a conventional solar evaporation shallow pond, which reduces about 40% area of solar natural evaporation pan. The salt recovered is also clean and fit for re-use in the tannery during experimentation. The evaporation rate of water in the effluent increases with increase in insolation, wind speed and decreases with increase in relative humidity, mass flow rate and effluent concentration.

This work will also give the ideas to augment the evaporation rate of effluent by the following ways:

- Forced air circulation can be used for augmenting the evaporation of water in soak liquor by employing cooling tower principle.

- The waste heat, from processes, boilers etc, can be utilised for water evaporation in the soak liquor in conjunction with cooling tower.
- Heat pump can also be used for increasing the solution temperature of the soak liquor, utilising the heat rejected from the condenser. Also utilising the refrigerating effect realized in the evaporator, water vapour evaporated from this system can be condensed simultaneously. Thus water can be recovered along with the salt for reuse apart from evaporating soak liquor.

NOMENCLATURE

C	concentration, %
E	evaporation rate, $\text{l h}^{-1} \text{m}^{-2}$
I	insolation, W m^{-2}
m	mass flow rate, l h^{-1}
RH	relative humidity, %
T_a	ambient temperature, $^{\circ}\text{C}$
W	wind speed, m s^{-1}
ϕ	latitude, degrees

REFERENCES

- [1] Mani, A., Venkatesh, A. and Ramanujan, T. K. 1999. Design, development and evaluation of solar augmented evaporation ponds for treatment of segregated tannery effluents (soak liquor). Final report. Vienna, Austria: United Nations Industrial Development Organisation (UNIDO).
- [2] Mani, A. and Srithar, K. 2001. Experimental studies on an open flat plate collector for treating tannery effluent. *Proceedings of the ISES Solar world congress (2001)*. Adelaide, South Australia,
- [3] Gandhidasan, P. 1995. Closed type solar regenerator: Analysis and Simulation. *Journal of energy resource technology* 117: 58- 61.
- [4] Gandhidasan, P. 1983. A simple analysis of an open regeneration system. *Solar Energy* 31 (3): 343-345.
- [5] Collier, R. K. 1979. The analysis and simulation of an open cycle absorption refrigeration system. *Solar Energy* 23: 357 – 366.
- [6] Kakabaev, A. and Golaev, M. 1971. Glazed flat surface as a solution regenerator for use in an absorption solar cooling system. *Geliotekhnika* 7 (4): 44-49.
- [7] Srithar, K and Mani, A. 2003. Comparison between simulated and experimental performance of an open solar flat plate collector for treating tannery effluent. *International communication in heat and mass transfer* 30(4): 505-514.
- [8] Srithar, K and Mani, A. 2004. Analysis of a single cover FRP flat plate collector for treating tannery effluent. *Applied Thermal Engineering* 24 (5-6): 873-883.